

# YANMAR



## 22918

### YANMAR YX-71-4 2.91:1

Brand Gearbox	YANMAR
Model Gearbox	YX-71-4
Ratio	2.91:1

General condition: **Brand New**

#### Features:

- Alum. Coupling
- Controls
- Hydraulics
- Brackets
- Oil Cooler



Amsterdam Alexandria Marine B.V.  
Luzernestraat 29,  
2153 GM Nieuw Vennepe,  
The Netherlands

lid  
koninklijke  
metaalunie

+31(0) 252 514 588  
info@aam-consulting.nl  
www.aam-equipment.nl  
www.aam-consulting.nl

## For Harmonious Living with Global Environment

Normally, when NOx emissions are reduced, the fuel consumption and smoke generation will increase, adversely affecting both the environment and management. As a solution to this, YANMAR has developed "EcoDiesel", which is designed so as to comply with marine environmental protection.

It improves the fuel consumption and smoke generation in addition to reducing NOx emissions.



Lower fuel consumption  
Lower NOx emissions

## Techniques for Complying with IMO Tier II Emission Standards : Exhaust Gas Recirculation (EGR)

In the 6AY engine, the internal EGR system is used. This design does not require any external control devices or any significant changes to the engine structure. In external EGR, the line of the engine and supercharger must be equipped with devices such as EGR solenoid valves and coolers, and control must be performed for them. But in internal EGR, these functions can be performed by controlling the lift of the intake and exhaust valve.

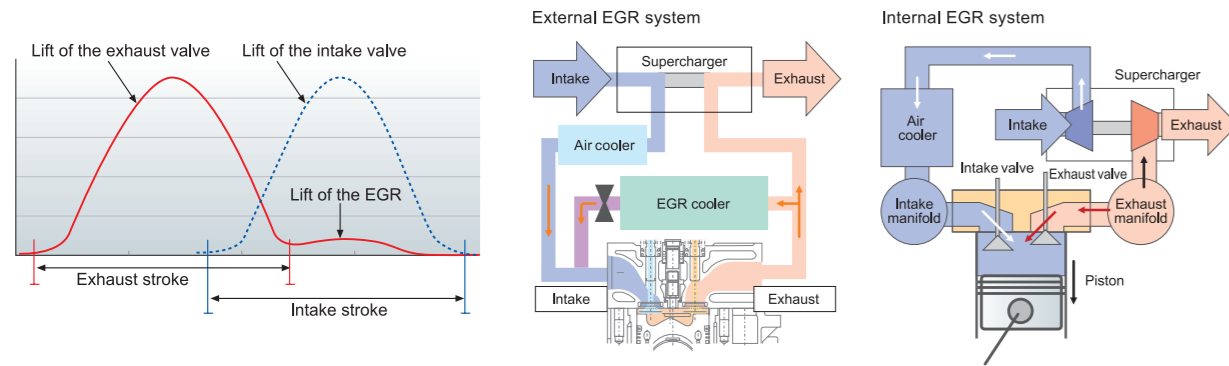

## Performance

**829hp ( 610kW ) at 1900rpm in the M operating mode / 755hp ( 555kW ) at 1840 rpm in the H operating mode**  
This 180 mm long stroker 20 liter class diesel, with 24 valves, the high performance turbo for, less turbo lag, and better mixing at low revs, the all-new high efficiency intercooler.

### Good Fuel Economy together with Lower Emissions

The micro-sized multiple holes in the all-new injectors produce an even finer fuel-oil mist and combined with deep combustion chambers and new cylinder head shapes, produce even more power. It is power delivered smoothly, due to optimum combustion conditions being maintained across a far wider operating range. And it leads directly to the bonus of lower exhaust emissions and lower fuel consumption.

The boost compensator dramatically reduces black smoke under hard acceleration.

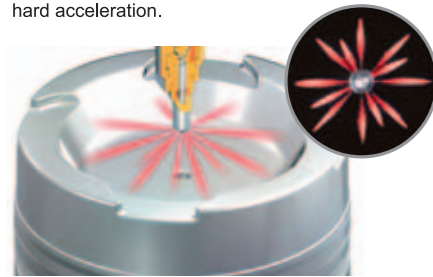

Staggered Layout Injection System

Both mono-grade and multi-grade lubrication oil can be used.



Cost of Saving (5%)  
In the case of an engine that consumed 100 liters of fuel per hour.

Annual Operation hour - 3,000hrs

Saving 5 liters / 1hr



Annual saving=15,000 liters  
200liters Drum×75

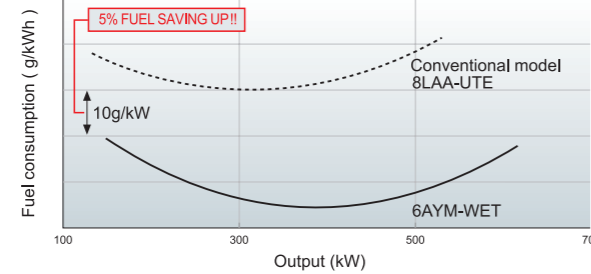
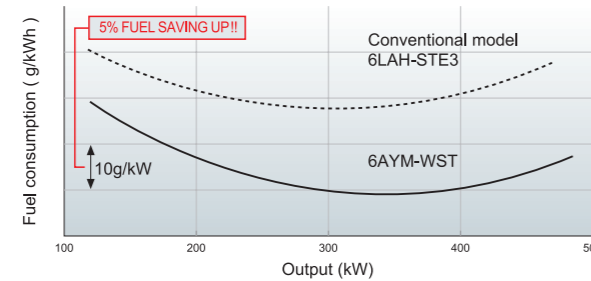

**YANMAR**  
Solutioneering Together

100th  
ANNIVERSARY

MARINE DIESEL ENGINE

**6AYM-WST**  
H-rating 485kW [ 659mhp ]  
**6AYM-WET**  
M-rating 610kW [ 829mhp ] / H-rating 555kW [ 755mhp ]

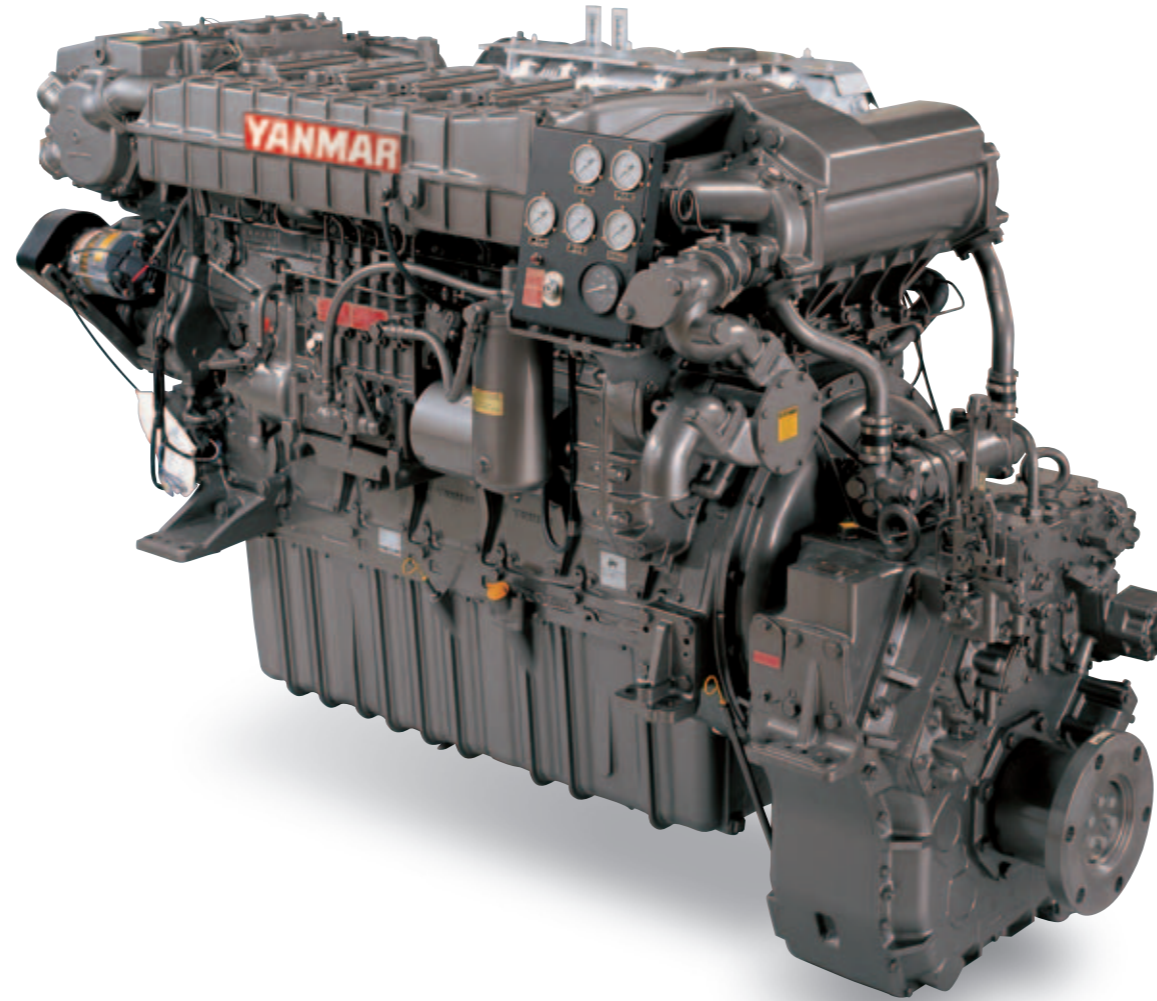

Photograph may show optional equipment.

IMO TierII Compliant  
Mechanical Engine Control

**659mhp**  
**829mhp**

**LONG  
STROKE**

### Engine Specifications

Model	6AYM-WST	6AYM-WET	
Type	4-cycle, Vertical, Turbo-charged with sea watercooled intercooler diesel engine		
No. of cylinders, Bore × stroke mm	6 in-line, 155 × 180		
Displacement lit.	20.379		
Rated output kW(hp) / min <sup>-1</sup> (rpm)	H: 485 (659) / 1900	M: 610 (829) / 1900	H: 555 (755) / 1840
Emission	IMO Tier II		
Fuel consumption gr/kW · hr	H: 207 ( at rated output )	M: 207 ( at rated output )	H: 202 ( at rated output )
Direction of rotation	Counterclockwise viewed from stern ( crankshaft )		
Combustion system	Direct injection		
Cooling system	With Heat exchanger [ optional keel cooling ]		
Cooling fresh water capacity lit.	60		
Lubricating system	Forced lubrication with gear pump		
Lubricating oil capacity lit.	91		
Lubricating oil grade	SAE40 or SAE15W-40		
Starting system	Electric starting motor ( DC 24V-8kW ) [ optional airstaring ]		
Flywheel housing size inch	SAE #0 and 18		
Dry weight kg	2365		

### Marine Gear Specifications

Engine Model	6AYM-WST / WET															
Marine gear model	YX-181 (WST only)			YX-180L (WST only)			YXH-240 (WET only)			YXH-240L						
Type	Hydraulic multi-disc clutch															
Reduction ratio	2.08	2.55	3.03	3.50	4.00	4.54	1.95	2.27	2.56	3.03	3.48	4.89	5.36	5.91	6.57	6.95
Direction of rotation	Clockwise or Counterclockwise															
Dry weight kg	560			680			645			1240						

### Dimensions ( Unit : mm )

#### Engine only / Front view

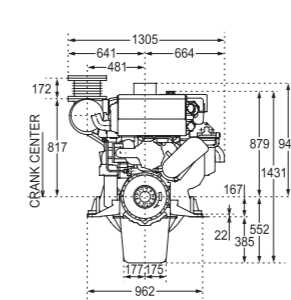

#### Engine only / Right side view

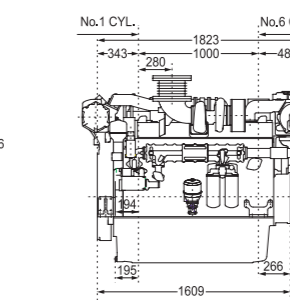

#### With YXH240L gearbox / Rear view

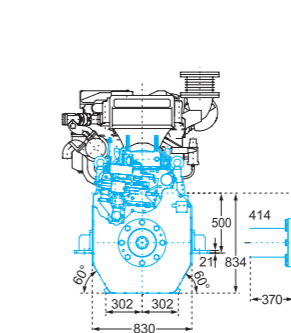

#### With YXH240L gearbox / Right side view

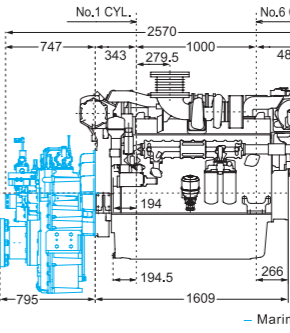

### Performance Curves

#### 6AYM-WST ( H rating )

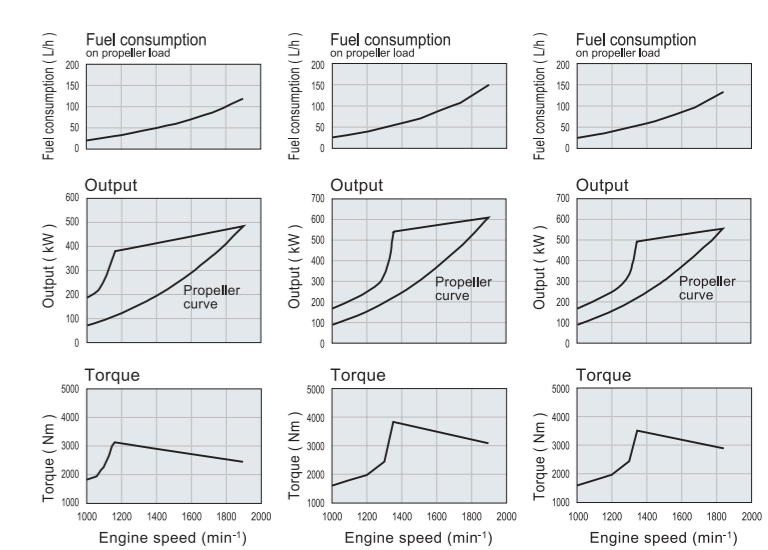

#### 6AYM-WET ( M rating )

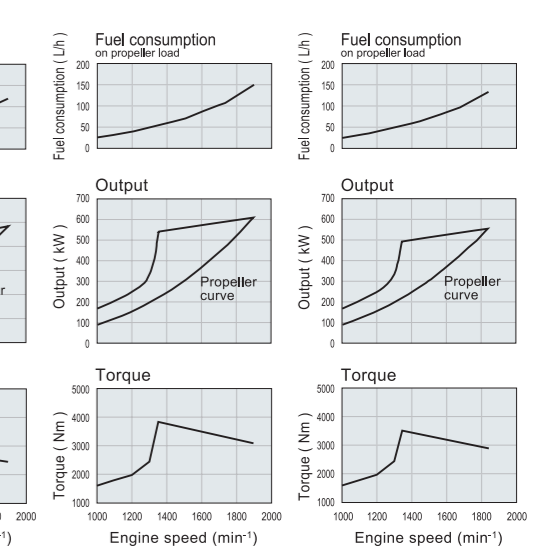

#### 6AYM-WET ( H rating )

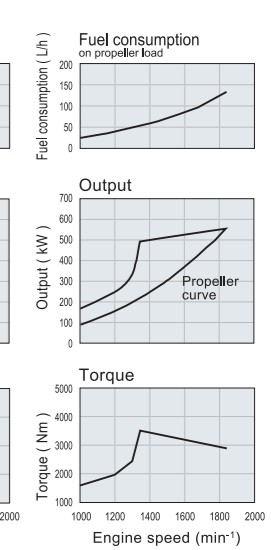

Rating definitions : hp=0.7355kW Ratings are based on conditions of 100kPa, 30% relative humidity at 25°C.  
M=For applications where use of rated power is less than 10 hours continuous and operation is less than 3000 hours per year. When combined with a correctly matched propeller which allows the engine rated speed to be achieved in a fully loaded vessel state, the reduced-power operation can be at or below 50 rpm of the rated speed.  
H=For applications where use of rated power is less than 24 hours continuous and operation is less than 4000 hours per year. When combined with a correctly matched propeller which allows the engine rated speed to be achieved in a fully loaded vessel state, the reduced-power operation can be at or below 50 rpm of the rated speed.  
Fuel rates : Specific gravity 0.835g/cc, low calorific value 42700kJ/kg (10200kcal/kg), Cetane No.45.

**YANMAR CO., LTD.**

Marine Operations Division.  
5-3-1, Tsukaguchi Honmachi Amagasaki, Hyogo, Japan  
Tel : +81-6-6428-3261 Fax : +81-6-6421-2202  
yanmar.com

Note : All Data Subject to Change Without Notice.

# YANMAR, Providing Quality Propulsion Engine Packages for Over 60 Years.

## Operation side

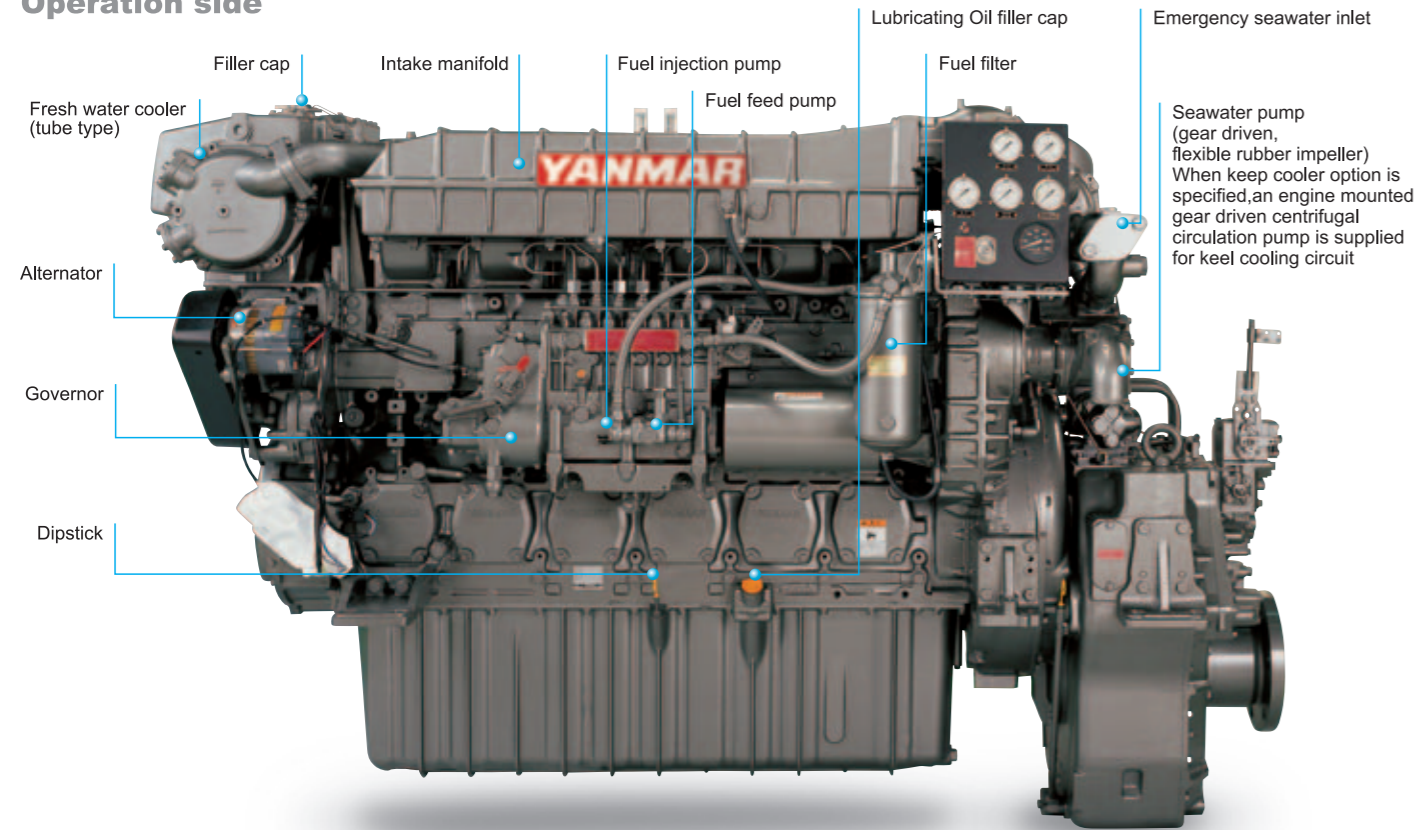

## Non operation side

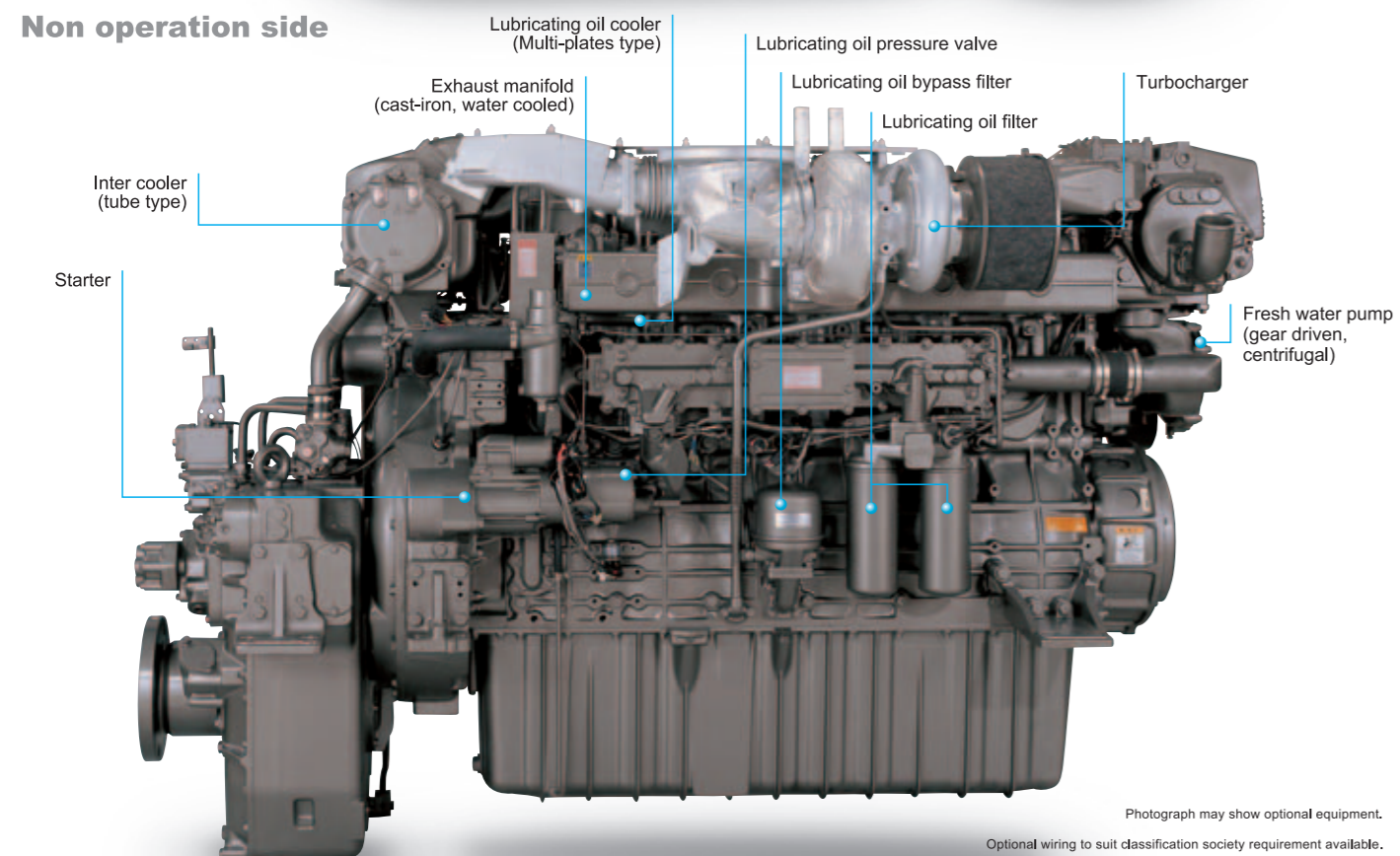

## High Torque

Excellent Torque-Rise Characteristics in High Speed and High Load Range Enable Stable Performance of Job Duties even at High Load

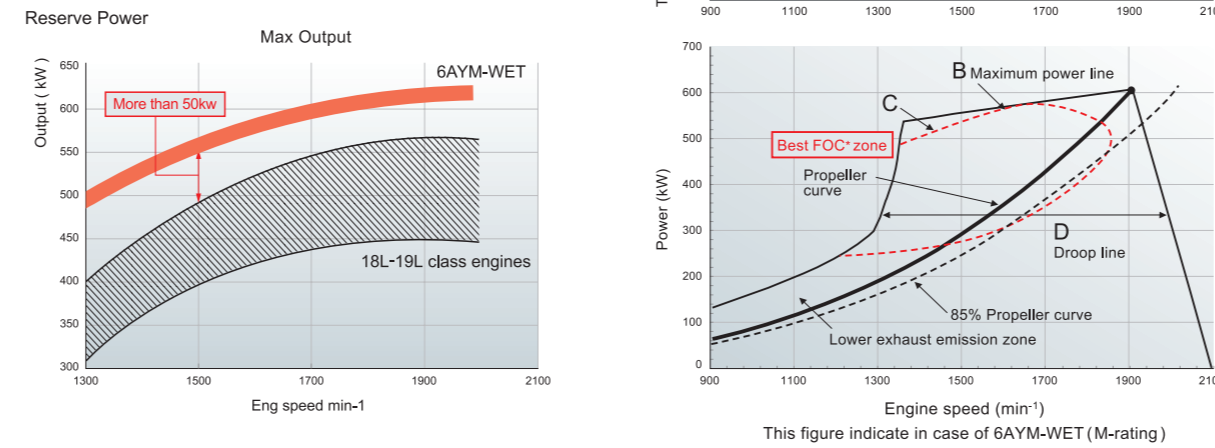

The Engine Performance Gives Following Advantages:

1. The engine torque-rise characteristics having much in reserve, ( Line A ) → Stable cruising with least speed reduction against sudden load changes.
2. Wide Max. Power Range, ( Line B ) → A wide range propeller matching, from the passenger ship (light/medium duty) to tug boat (heavy duty), is possible.
3. Min. Fuel Consumption Range is Wide, ( Line C ) **Best FOC zone** → Economical with wide min. fuel consumption range both during cruising or performing job duties. \* FOC: Fuel Oil Consumption
4. Wide Medium Load Range, ( Line D ) → Produces stable engine performance even doing other job duties.

## Toughness

1. Low, stable LOC (Lubricating Oil Consumption) and long overhaul interval, thanks to sillicard\*\* (kind of artificial ceramic) treatment cylinder liner and nitrided stainless steel rings and the finely judged clearance between piston and liner. No cylinder kit replacement concept in YANMAR overhaul program.
2. Purpose built marine engine with long stroke, optimized flywheel weight, water cooled exhaust manifold and special treatment injection nozzle. A Leak-free engine.
3. Type Approved by Marine Class Societies.

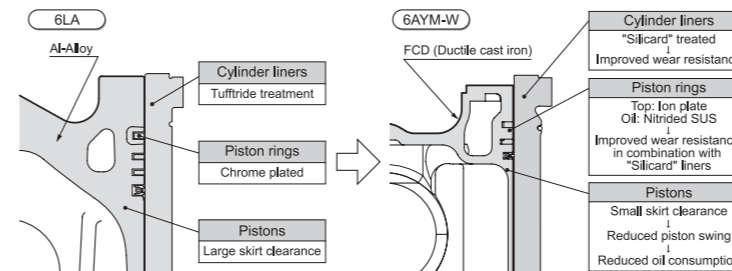

## Lower Down Time

Easier Routine Inspection, Easier Maintenance.

1. Large inspection windows on the side of the block allow in-site replacement of pistons.
2. Full mechanical engine management avoids the chance of delicate and expensive electronics failing in hot, marine engine room conditions.
3. 500 hours service interval.
4. Individual cylinder heads for each cylinder.

## High capacity front PTO

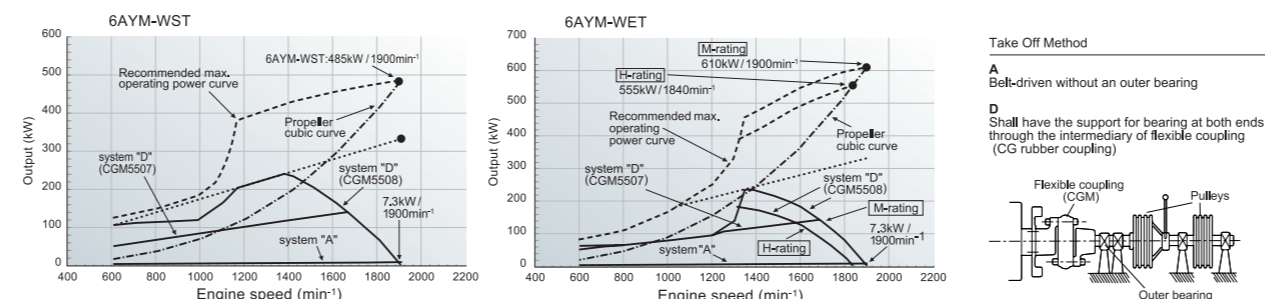

## YANMAR original marine gear that can be adapted to a wide range of applications

YANMAR provides our original gearbox, which enables us to supply total marine engineering & servicing to customers!

### High-Performance Marine Gear

YANMAR's original marine gear is designed to draw out best performance of YANMAR engines.

### Easier Maintenance

The 3-part structure of the case enables the forward shaft and reverse shaft to be disassembled and reassembled while still installed on the boat. In addition, a cartridge system is now used for the L.O. filter.

### Marine class societies approval

### Accessories

Optional Trolling Device (BX Type trolling).  
Optional Trailing pump.  
Propeller shaft half coupling (counter flange) supplied as standard.

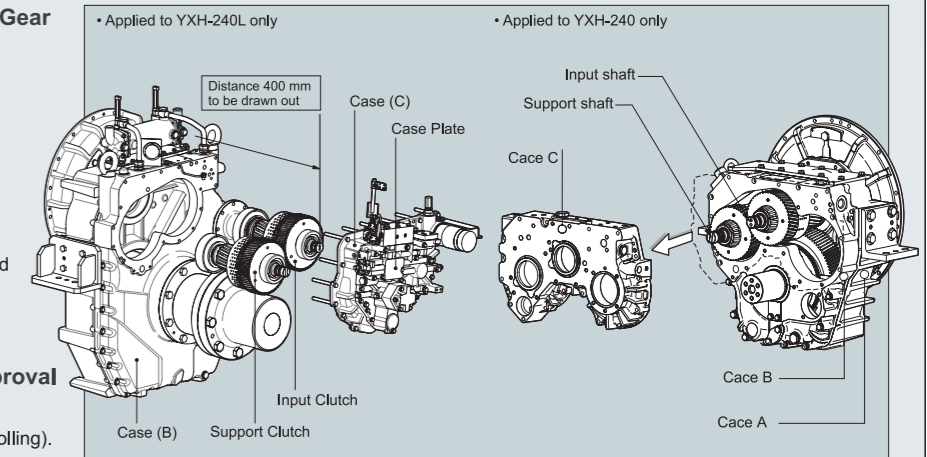

### Bx Type Trolling operation principle

The trolling device consists of the low speed valve and governor valve that detects the output shaft rotation speed. The clutch hydraulic oil pressure is decided by the balance between the value instructed by manipulating the trolling change-over lever of low speed valve and governor pressure so that the output rotation speed can be stabilized against the fluctuation of load.

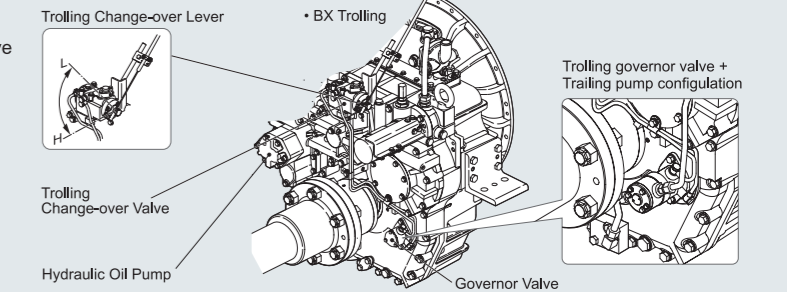

## YANMAR original rubber mounts (option)

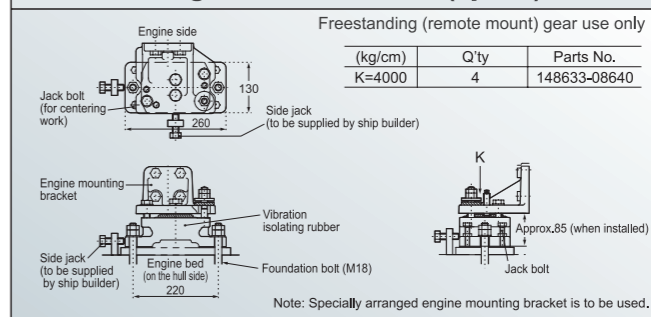

Detail of instrument panel D-type (Unit : mm)

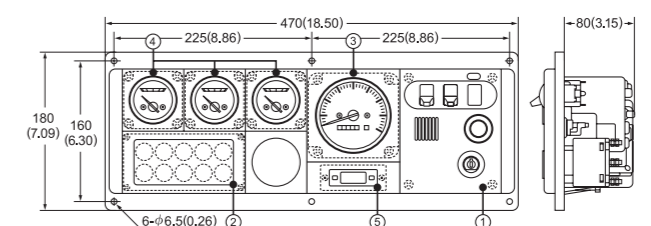

- 1 Switch unit
  - Key switch
  - Alarm buzzer
  - Alarm buzzer stop switch
  - Illumination switch
- 2 Alarm lamp unit with Alarm monitor device
  - Battery not charging
  - C.W. high temp.
  - L.O. low pressure
  - Clutch oil pressure
  - L.O. filter clogged
  - C.W.level
- 3 Tachometer unit
  - Tachometer with hour meter
- 4 Sub meter unit
  - L.O. pressure meter
  - C.W. temp. meter
  - Boost meter (Turbo)
- 5 Clock unit
  - Clock

